



BTA-VOL2

QUICK START INSTALLATION GUIDE FOR 2006-UP VOLVO RADIOS WITH AUX AUDIO INPUT MODE

Created: August 2018
Revised: December 20, 2024

PRODUCT SAFETY & DISCLAIMER

READ ALL INSTRUCTIONS CAREFULLY BEFORE INSTALLING, FAILURE TO DO SO MAY CAUSE PERSONAL INJURY OR DAMAGE TO PRODUCT AND/OR PROPERTY

- This document is provided as a GENERAL installation guide, some vehicles vary and may require additional steps. We do not accept responsibility for third party labor charges or modifications. Exercise due-diligence when installing this product.
- We do not accept any responsibility for vehicle damage or personal injury resulting from the installation of this product.
- Careless installation and operation can result in equipment damage.

Requirements

radio with aux menu option

Introduction

Many 2006-Up Volvo include options such as Aux input jack, satellite radio, Bluetooth hands-free but lack music streaming. If the radio in your Volvo has a "MODE" button capable of selecting "AUX audio input; the BTA-VOL2 adds music streaming from smartphone, Tablet, Kindle and more and will not interfere with factory installed options. Factory AUX jack (if equipped) remains active. The BTA-VOL2 works only if Menu button is able to select "AUX Audio Input ". For verification, press "MODE" button repeatedly until "AUX Audio Input" is displayed. **Radios with "CD" button are not compatible.**

Installation

To install, user must gain access to the back of the radio.

1. Detach the panel at the rear edge of the center console:
Use a plastic dash removal tool to pry loose the panel. Panel is secured by a catch on each short side. See **Fig. 1**

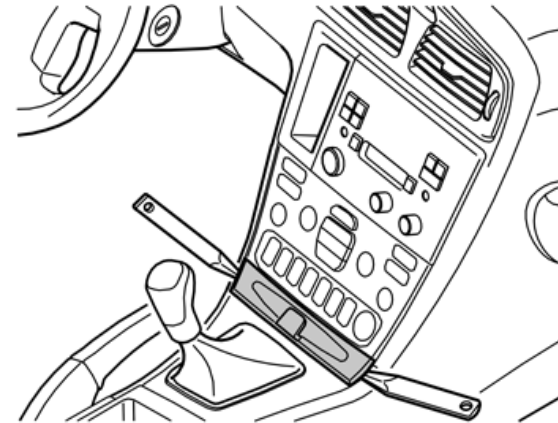

Fig. 1

2. Remove plastic surround piece around display: (See **Fig. 2**)
Use a small screwdriver and press in the catches on upper corners. Carefully pry off the surround on that side using a plastic dash removal tool. Fold the surround backwards into the vehicle. Pull the surround up until it detaches. (See **Fig. 2**)

Hint: If panel is difficult to remove, press panel on both sides again and repeat the procedure starting at the other side.

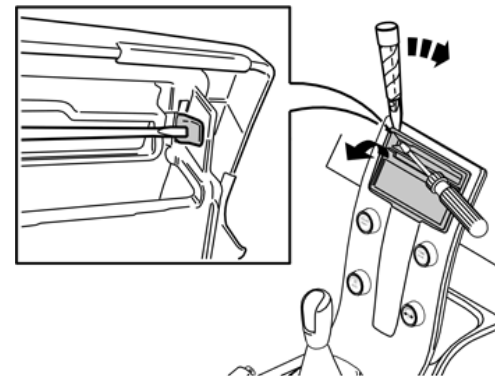

Fig. 2

3. Remove the ignition control module (ICM) – See **Fig. 3**. It is secured by two hidden clips (one on each side). Grip with both hands and pull then disconnect the two plugs. Put display to one side

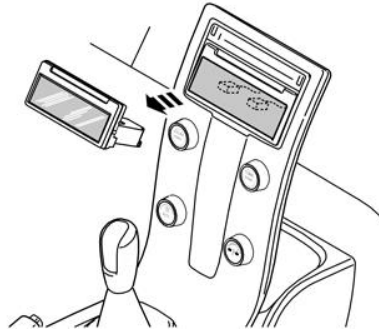

Fig. 3

4. Remove (2) screws (Torx 25) holding the center console to dashboard. Remove green plug on the reverse side of climate control panel. (See **Fig. 4**)

Note: Vehicles with updated dashboard or without panel at the rear edge of the center console (See **Fig. 5**) (e.g. 2008+ models), skip to step 13.

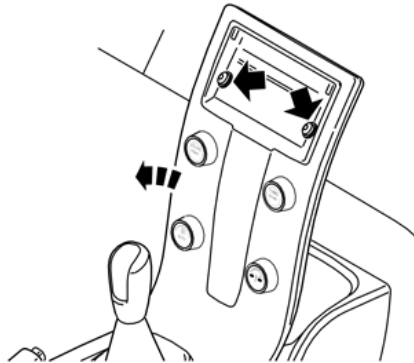

Fig. 4

5. Detach panel at the rear edge of center console:
Use plastic dash removal tool to pry loose the panel. Panel is secured by a catch on each short side. Remove panel to access the two screws underneath.

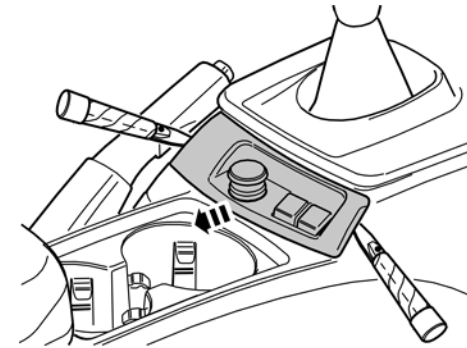

Fig. 5

6. Remove the two screws (Torx 25) holding center console at rear edge (See **Fig. 6**)

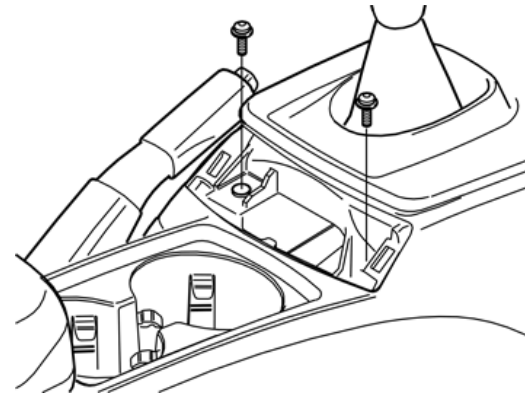

Fig. 6

7. Pry up and remove front storage compartment (See **Fig. 7**)

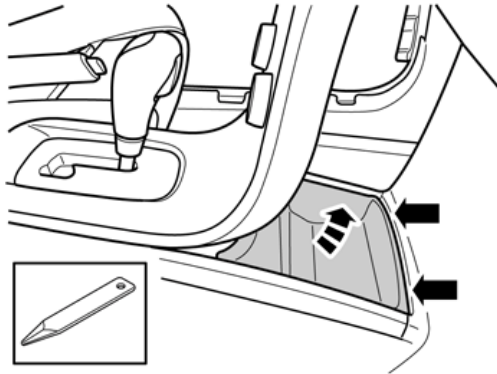

Fig. 7

8. Pry up cover in rear storage compartment and remove two screws (Torx 25) (See Fig. 8 & 9)

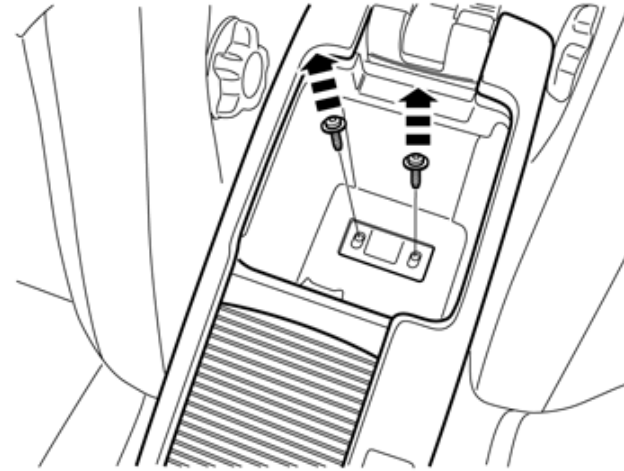

Fig. 9

9. Carefully detach hand-brake panel and remove (See Fig. 10)

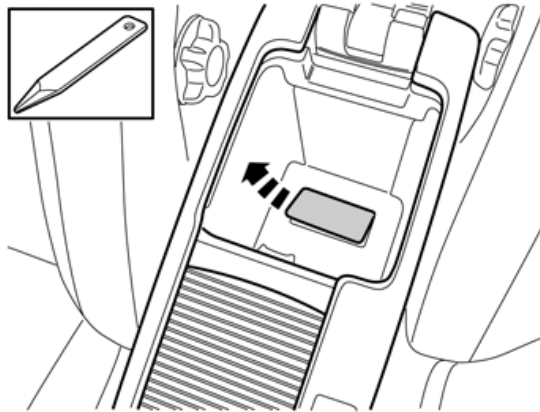

Fig. 8

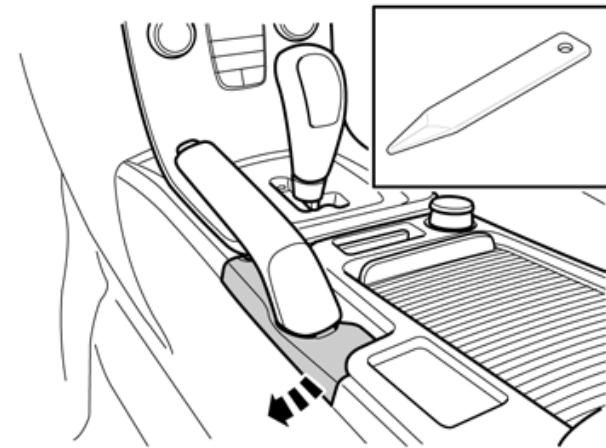

Fig. 10

10. Remove two screws from top edge of center console (See Fig. 11)

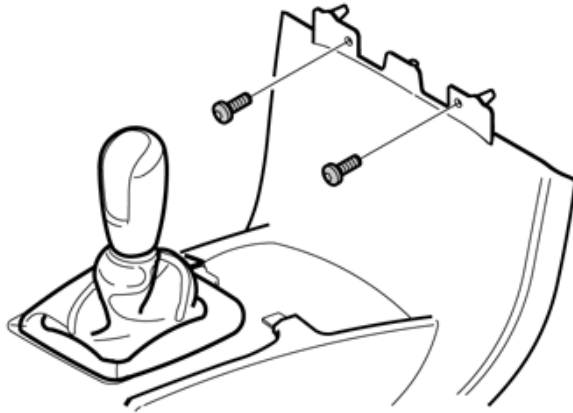

Fig. 11

11. Carefully pry up the lock catch using pry tool or flat screwdriver (See Fig. 12). At the same time, slide the whole tunnel console backwards so to gain access to the two rear screws on center console's panel. (See Fig. 14)

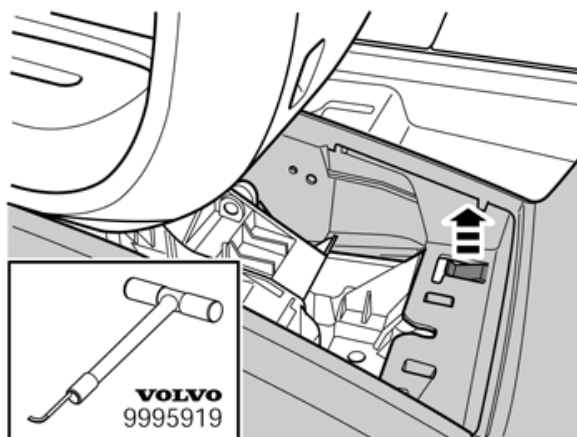

Fig. 12

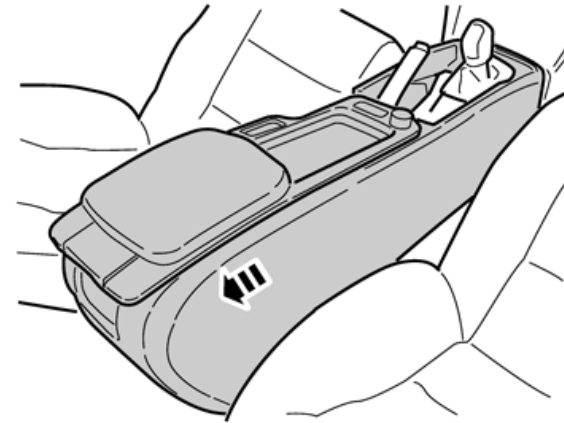

Fig. 13

12. Remove two screws (Torx 25) as seen in Fig. 14.

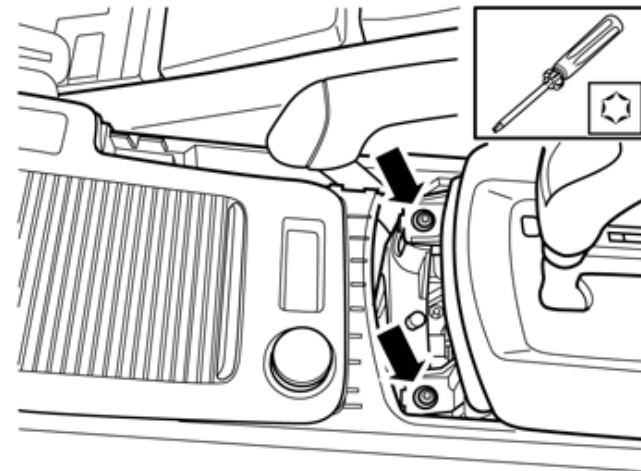

Fig. 14

13. Remove panel from dashboard and center console (See Fig. 15)

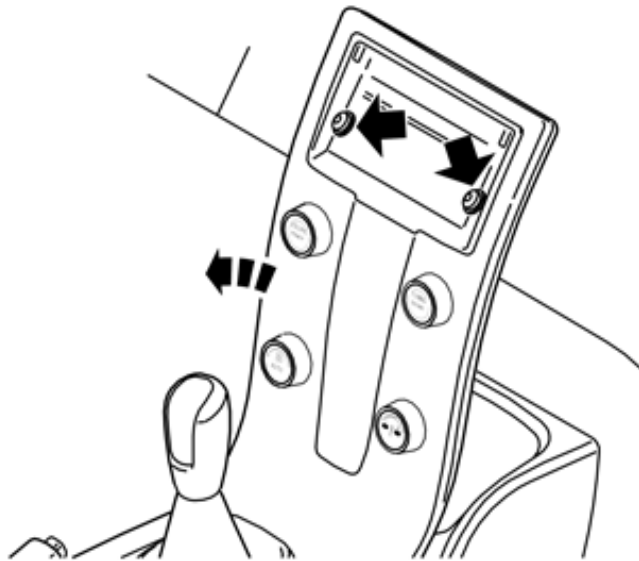

Fig. 15

14. Remove two screws (Torx 25) securing CD player to dash.

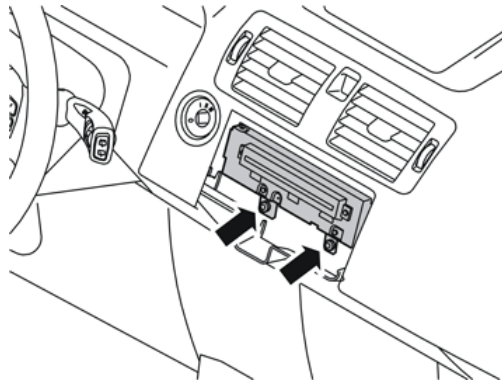

Fig. 16

15. Remove CD player/radio and disconnect gray power/speaker plug (1) (it is not necessary to disconnect fiber (4) or antenna plug) See Fig. 17.
Radio may be stuck and extra force may be required.

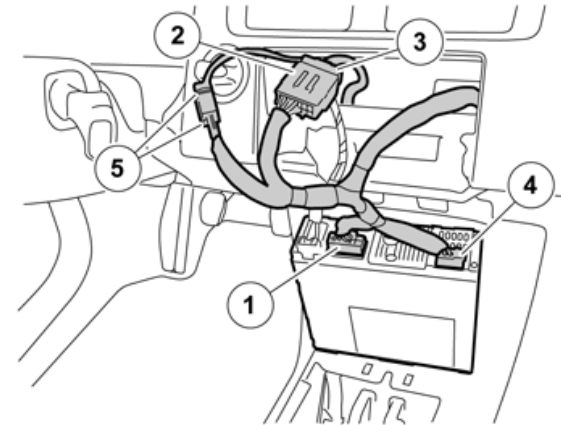

Fig. 17

16. Connect installation harness 14-pin Male plug (See Fig. 18) to CD player/changer slot vacated in step 15. (See Fig. 18)
Ensure plug is fit snug otherwise speaker may play intermittently.



Fig. 18

17. Connect factory 14-pin male plug (removed in step 15) to installation harness 14-pin connector (See Fig. 19)

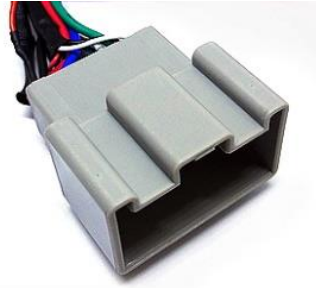

Fig. 19

18. Place Bluetooth module behind radio cavity
19. Route (red) accessory wire to cigar lighter outlet or other circuit controlled by ignition switch and use included T-Tap to make the connection.
Avoid connecting accessory wire to permanent 12V supply (battery).

Volvo XC90 radio removal

1. Move the gear selector lever to its rearmost position. See **Fig. 20**

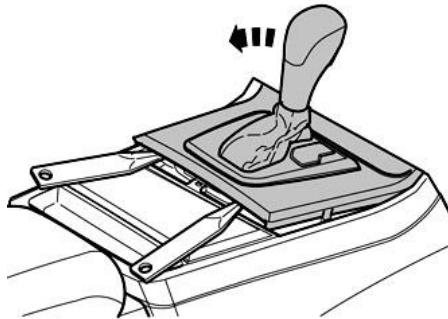

Fig. 20

2. Use a weather strip or pry tool and pry off the gear selector panel at the rear edge. See **Fig. 20**

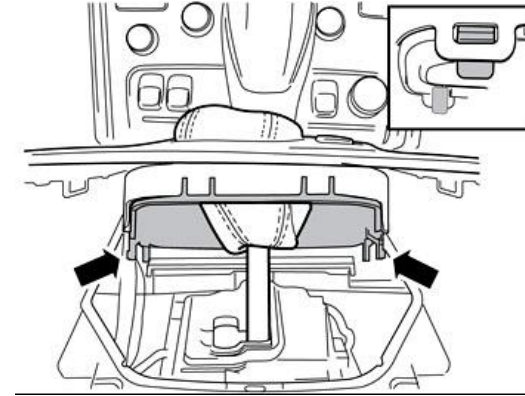

Fig. 21

3. Remove the two Torx screws. See **Fig. 21**
4. Remove the bracket with the A/C panel and radio from the center console. Pull from the lower edge and then downwards until it releases from the mounting at the upper edge. (See **Fig. 22**)

Note!

Do not damage the removed components or surrounding panels

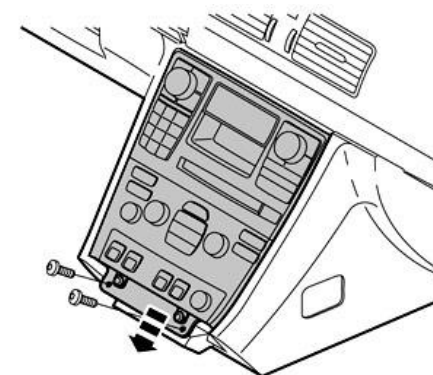

Fig. 22

5. Lay out a cloth to protect the tunnel console and unit, as illustrated in **Fig. 23**. Depending on the design the cable may need to be disconnected and the unit placed to one side.

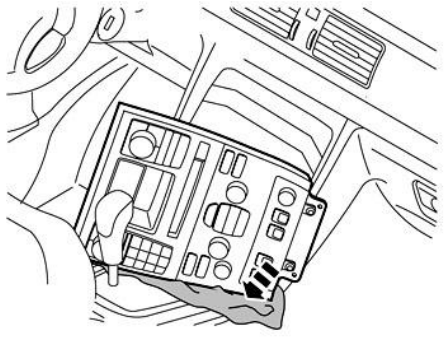

Fig. 23

6. Press release tab on factory 14-pin gray plug and disconnect from CD player. (See Fig. 24).



Fig. 24

7. Connect installation harness 14-pin Male plug (See Fig. 25) to CD player/changer slot vacated in step 6. Ensure plug is fit snug otherwise speaker may play intermittently.



Fig. 25

8. Connect factory 14-pin male plug (removed in step 6) to installation harness 14-pin connector (See Fig. 26)

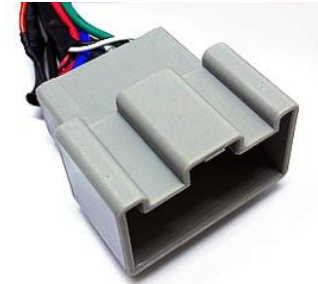

Fig. 26

9. Place Bluetooth module behind radio cavity
10. Route (red) accessory wire (See Fig. 27) to cigar lighter outlet or other circuit controlled by ignition switch and use included T-Tap to make the connection. **Avoid connecting accessory wire to permanent 12V supply (battery).**
11. Connect installation harness 16-pin plug (See Fig. 27) to module 16-pin connector (See Fig. 28)



Fig. 27



Fig. 28

12. Reinstall radio by reversing install steps

Pairing

Pairing process varies among devices but steps are the same and done upon initial install and will not have to be repeated.

1. Turn ignition and radio "ON"
2. From your Bluetooth enabled device, turn the Bluetooth ON and search for Bluetooth devices.
3. When a list of available Bluetooth devices appears on your Bluetooth device, select "DisCarSt" (See Fig. 29)
4. Confirmation "tone" is heard on car speakers.
5. The unit will automatically enter the BT Audio source and you can now start streaming audio from your Bluetooth enabled device.

Note: If the mobile phone doesn't support SSP (Simple Secure Pairing) Profile, please enter the pass code of "0000"

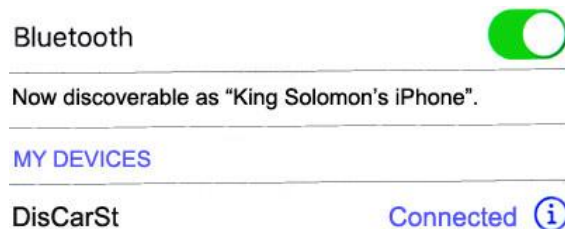

Fig. 29

Operation

1. Reconnect display module and climate control panel to green plug.
2. Turn ignition to position II
3. Turn ignition and radio "ON"
4. Press "MODE" button until AUX AUDIO INPUT is displayed (See Fig. 30)



Fig. 30

5. On smart device, Launch streaming application of choice
 6. Use wireless remote control buttons or device built-in controls to change tracks, adjust device volume, pause etc. (See Fig. 31)
 7. To listen to AUX device (if available), tap **Pause/Play** on remote control.
 8. To switch back to streaming, tap **Pause/Play** button on remote control
- Note:** To adjust volume (+/-) use tapping action instead of tap and hold



Fig. 31

9. If correct operation is confirmed go ahead and reinstall radio.

Frequent ask questions & troubleshooting

- 1. Does the BTA-VOL2 require an AUX jack to work?**
AUX jack not required but if present it remains functional.
Radios with "MODE" button are compatible, however radios with "CD" button are not compatible.
- 2. Will the BTA-VOL2 disable existing aux jack?**
NO; the factory aux jack remains functional and is not disabled.
- 3. Does the BTA-VOL2 support phone calls?**
NO; The BTA-VOL2 does not support hands-free calls.
- 4. Does the BTA-VOL2 work with all Volvo radios?**
NO; this module works in Volvo C30, S40, C70, V50, V70, XC60, XC90 with CD/CD changer radios (AM/FM radio is built-in to CD/Changer). Radio must have "MODE" button with AUX menu option. Does not work in vehicles (e.g. XC70/90) with CD/Changer radio where the AM/FM Tuner module is in separate location (e.g. hatch). AM/FM Tuner must be built-into the dash mounted CD/CD changer.
- 5. My Volvo has factory "PHONE" module which only works for phone calls. Does the A2D-VOL2 work in this application?**
YES; The BTA-VOL2 adds music streaming option to your vehicle and does not interfere with factory installed hands-free kit. Simply pair smartphone to vehicle hands-free kit (phone calls) and to the BTA-VOL for streaming.
- 6. Does optional remote control Volvo radio functions?**
NO; optional remote functions are applicable to smartphone only.

Disclaimer

- This product has no affiliation with Volvo.
- There are no warranties expressed or implied by purchase of this product
- When possible, professional installation is recommended

For additional questions, email support@discountcarstereo.com

© 1995-Dec-24 Discount Car Stereo, Inc. All rights reserved. Information in this document is subject to change without notice. Other products and companies referred to herein are trademarks or registered trademarks of their respective companies or mark holders.